E-BOOK

[Shortwave Overview](#)

- [Introduction](#)
- [Application](#)
- [Indications](#)
- [Contraindications](#)
- [Dosage](#)

[Program Navigation](#)

- [Thermal Dosimetry](#)
- [Manual SWD Settings](#)
- [Clinical Protocols](#)

[Features](#)





Shortwave Overview

- [Introduction](#)
- [Application](#)
- [Dosage](#)



Introduction:

What is Shortwave Diathermy (SWD)?

- Clinical application of electromagnetic energy to the body in the radio frequency of 27.12 MHz

What does it do?

- Electromagnetic energy is converted to thermal energy:
 - dielectric absorption in insulating tissue
 - induction of circulating currents in the tissue
- Produces thermal and A-thermal response with physiological and therapeutic effects

• Induction Field Method:

- Body area is within a magnetic field produced from a coil in a drum
- Produces high frequency currents within the tissue
 - Effectively heats tissue with low impedance, such as muscles, thus the inductive method is preferable for heating deeper tissues

▪ Electrodes:

- Monode “drum”
- Diplode

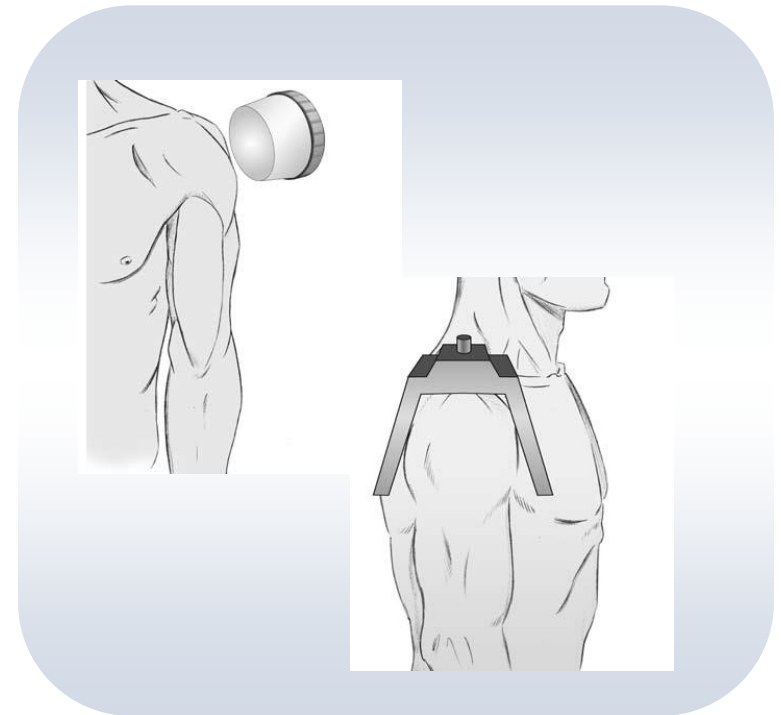
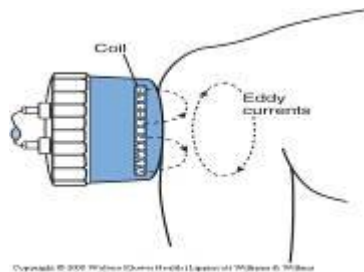

- Capacitive Field Method:

- Body part is within the electric field between two electrodes forming a “capacitor”
- The “radiation” produces a warming of the body part located within the field
 - Superficial and high density tissues are warmed more effectively: skin, tendon, ligament, joint capsule & bone
- Electrodes:
 - Capacitive plates
 - Flexible rubber electrodes

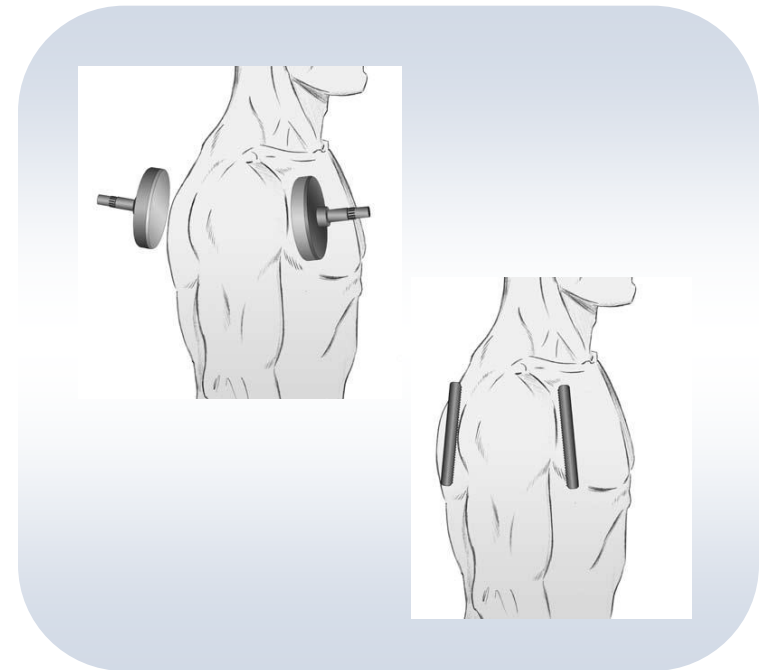



• Ultrasound and Shortwave Diathermy Comparison

	<u>Ultrasound</u>	<u>Shortwave Diathermy</u>
Energy type:	Acoustical	Electromagnetic
Tissue heated:	Collagen-rich	C: Skin, adipose tissue I: Muscle, vessels
Tissue volume:	Small (20 cm ²)	Large (200 cm ²)
Temp increase:	1 MHz: > 6.3°F 3 MHz: > 14.9°F	C: > 7°F I: > 18°F
Heat retention:	3 min	> 9 min

C = Capacitive method
I = Induction method



- Advantages of Shortwave Diathermy
 - **Deep** penetration, up to 5cm
 - **Hands-free** Application - You can use it while attending to another patient, which allows you to manage your time in the clinic
 - It covers **large** areas
 - It can heat the deeper tissue ***without heating the superficial tissue***
 - **Non-contact** application possible - e.g. sensitive tissues / lesions etc...



Application:

- Normally applied at levels to produce detectable heating
- Provides “deep heat” within the tissue whereas typical thermal treatments apply external heat
- Benefits associated with heating effect:
 - Increased localized circulation
 - Pain relief
 - Reduction of muscle spasm
 - Increase range of motion
 - Contractures

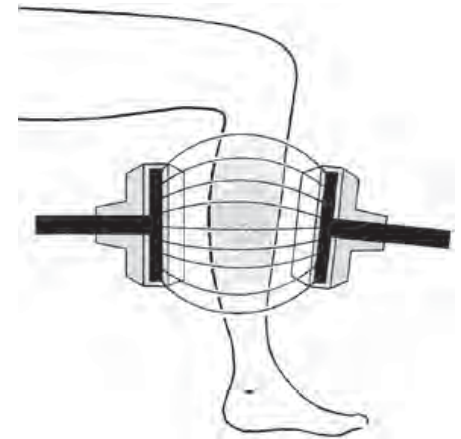



Continuous Mode - CSWD:

- Delivers continuous shortwave energy up to 100W

Pulsed Mode - PSWD:

- Delivers shortwave energy in short pulses or bursts
 - Typical pulse width (duration) range: 20 – 400 μ sec
 - Typical pulse frequency (repetition) range: 10 – 800 Hz
- Pulsed output allows mean power to be very low and still provide effective treatment
 - Max peak power: 200W
 - Average (mean) power: 64W

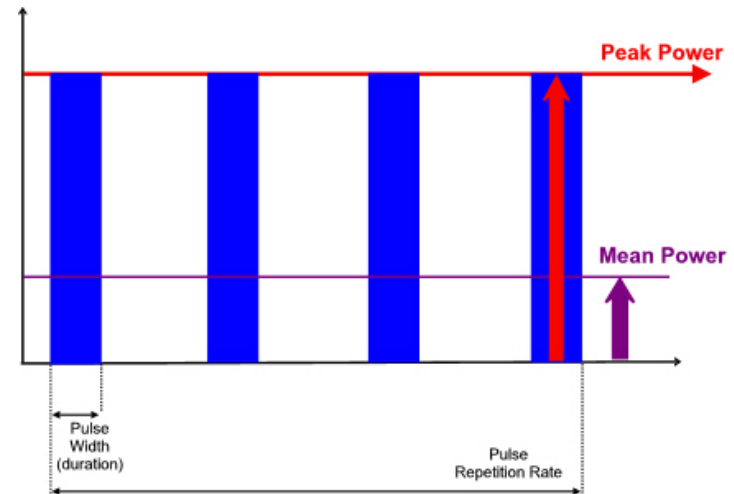



Reported Physiological Effects Summary**

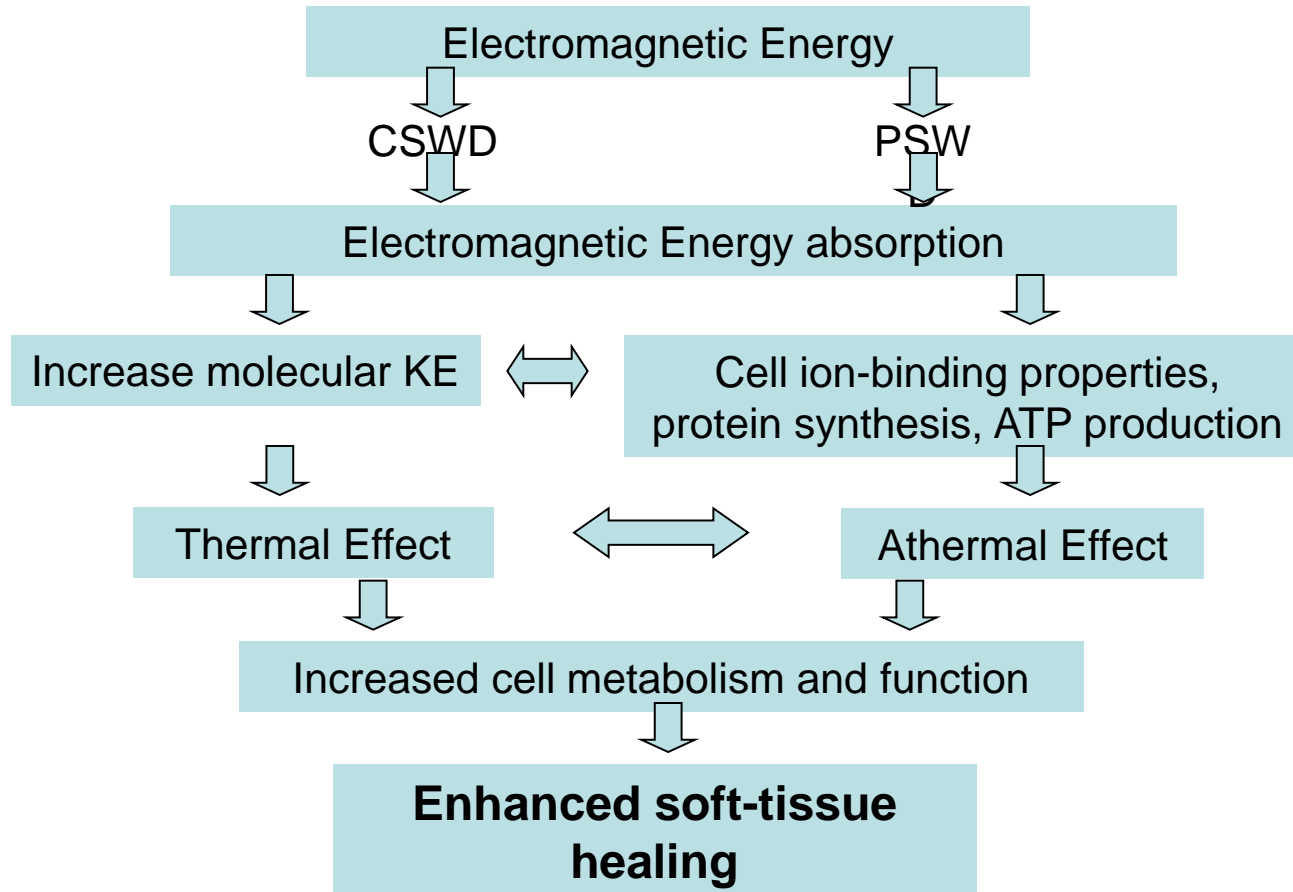



- **Clinical Effects**

- **Inflammatory Conditions**

- Assists in removal of cellular debris and toxins
- A-thermal:
 - Alters diffusion rate across the cell membrane
- Thermal:
 - Increases intramuscular metabolism

- **Primary Markets**

- Sports Medicine / Pain Management
- Outpatient
- Chiropractic



- **Clinical Effects**

- **Blood and Fluid Dynamics**

- Vasodilation increases:
 - Blood flow
 - Capillary filtration
 - Capillary pressure
 - Oxygen perfusion
- Increased fibroblastic activity and capillary growth

- **Primary Markets**

- Outpatient
- Skilled Nursing Facility (SNF)



- **Clinical Effects**

- **Tissue Elasticity**

- SWD can vigorously heat deep tissues
- Alters collagen properties, allowing it to elongate
- Requires stretching during and/or immediately following the treatment
- Multiple treatments are required

- **Primary Markets**

- Inpatient Rehab Facilities
- SNF

- **Market Opportunities**

- Sports Medicine
- Chiropractic



- **Clinical Effects**

- **Increased Blood Flow**

- A-thermal SWD increases rate of phagocytosis
- Number of mature collagen bundles increase
- ATP activity increases (assisting tissue regeneration)
- Necrotic tissue decrease

- **Primary Markets**

- Skilled Nursing Facilities
- Long Term Acute Care Hospitals

- **Market Opportunities**

- Sports Medicine



Indications:

- Pain Relief
- Reduction of Muscle Spasm
- Increased Localized Blood Flow
- Joint Contractures
- Decrease of Joint Stiffness
- Chronic Inflammatory or Infective Conditions:
 - Bursitis
 - Tenosynovitis
 - Synovitis
 - Chronic Inflammatory Pelvic Disease





Contraindications:

- Any patient with an implanted electronic device such as a cardiac pacemaker, bladder stimulator, spinal cord stimulator or electrodes for a myoelectric prosthesis, or implanted metallic leads, must not be treated with shortwave diathermy and should not be subjected to shortwave diathermy. Do not use on patients who have had an implant in the past unless you are absolutely certain that the implant and all leads in their entirety have been removed. Note that leads are often left implanted after the implant is removed. The effects of the applied high frequency on the pacemaker could cause ventricular fibrillation. Any other persons with pacemakers must also remain outside of the treatment area during shortwave diathermy. No one wearing a cardiac pacemaker should be within 20 feet (inductive field) or 50 feet (capacitive field) of an operating unit.
- Patients whose condition could be negatively affected by heat.
- Patients with hemorrhages or risk of hemorrhage.
- Patients with septic conditions and empyemas.
- Patients with malignant tumors and undiagnosed tumors.¹
- Implants, areas where implants have been removed, damaged implants, and metal inclusions².





Contraindications:

- Implants that could be impaired by shortwave diathermy irradiation.
- Swellings that still feel warm.
- Thermohypesthesia (diminished perception of temperature differences).
- Thermohyperesthesia (very acute thermoesthesia or temperature sense; exaggerated perception of hot and cold).
- Acute inflammations.
- Severe arterial obstructions (stage III and IV).
- Gynecological disorders involving acute inflammation³.
- Permeating irradiation of the thorax in cases of severe heart diseases (heart valve diseases, myocardial insufficiency, myocardial infarct, severe coronary sclerosis).
- Wetness, perspiration, or damp bandages.





Contraindications:

- Pregnancy, since irradiation of the abdomen could cause teratogenous damage due to alterations of blood circulation and diffusion.
- During the menstrual cycle.
- Over the pregnant or potentially pregnant uterus. Therefore, shortwave diathermy should not be applied over the uterus unless specific assurance can be attained from the patient that she is not pregnant.
- Sudeck's syndrome, stage I and II.
- Basedow's disease (irradiation could cause serious states of agitation).
- Varicose veins (irradiation could cause congestive pain).
- Particular care must be taken if the patient's clothing is wet or damp, since the garments may heat up faster and more intensely than the patient's body.
- Cardiac conditions.





Contraindications:

- Deep vein thrombosis, phlebitis, varices.
- Synthetic fibers (perlon, nylon, etc.) are characterized by low absorbency, which can cause the skin beneath such fabrics to quickly become moist. Therefore, it is recommended that the body areas to be treated be completely unclothed and the patient's skin dried, particularly where perspiration accumulates in folds of the skin. This applies especially when a higher dosage is being applied. There is no danger, however, when applying shortwave diathermy irradiation to bandaged areas as long as the bandages are completely dry.
- When treating small children, particular care is obviously required due to the low body weight. Very careful dosing and constant observation (manual checks of the skin temperature while the unit is switched off) are necessary.
- The output power must always be set according to the subjective response of the patient. Therefore, special care must be taken in case of patients with a diminished capacity for perception of heat (refer to "Dosage Levels According to Schliephake).
- Since the effects of high-frequency fields on unborn life have not yet been sufficiently researched, we recommend that operators who are pregnant do not remain in the immediate vicinity of the applicator when the unit is activated.





Contraindications:

- It is advisable to post warnings for wearers of pacemakers in the rooms where high-frequency therapy (e.g. shortwave diathermy) is applied.
- A distance of at least 20 feet must be maintained between the unit and any low-frequency therapy that is being used.
- Arterial disease, circulatory insufficiency.
- Over eyes.
- Over reproductive organs.
- Over cardiac pacemakers and defibrillators, cochlear implants, bone growth stimulators, deep brain stimulators, spinal cord stimulators, and other nerve stimulators.
- Over open lamina (after laminectomy; spina bifida).
- Over superficial endoprosthesis or metal implants.
- Neoplastic tissues or space occupying lesions.





Contraindications:

- Directly over the carotid sinuses, ceruical stellate ganglion, or Vagus nerve located in the anterior neck triangle.
- Direct application over cancerous tumors or lesions due to its potential to increase blood flow to the area of malignancy.
- Occlusive vascular disease, such as arteriosclerosis obliterans and thromboangitis obliterans, in which organic occlusion and ischemia are evident.
- Directly over the epiphysis of growing bones in children and adolescents because shortwave diathermy therapy may enhance or inhibit bone growth.
 - **NOTE:** The mean age for skeletal maturity is 15 ½ years in females and 17 ½ years in males.
- In the presence of systemic or local infection (sepsis, Osteomyelitis, tuberculosis) or if the patient has an elevated temperature.





Contraindications:

- In areas where metal is present due to eddy current generation of excessive and uneven heat distribution. Metal objects within the treatment area should be removed and placed outside the electromagnetic field. These include, but are not limited to metal:
 - Metal in the environment:
 - Within one foot of beds, treatment tables, standard chairs, wheelchairs, swivel stools, step stools, splints, braces, scissors, forceps, and scalpels.
 - Within 20 feet of electronically controlled medical devices such as, CPM devices, electric wheelchairs, electrotherapy devices or other electrical systems, computers, etc.
 - Metal near the patient:
 - Jewelry, body piercing earrings, watches, keys, coins, belt buckles, underwire bra, hearing aids, zipper in clothing or pillow cases.
 - Metal objects within the treatment area that cannot be removed should be avoided. These include, but are not limited to:
 - External metal: orthodontic braces, dental fillings, staples, external fixation devices.
 - Internal metal: valves, joint replacements, metal IUDs, shrapnel, metal implants, internal fixation devices-rods, plates, screws, wires, etc.
 - **NOTE:** If there is a scar in or near the treatment area, check with the patient and/or the patient's chart to determine if there is metal under the scar.





Contraindications:

Footnote References:

- ¹According to Schneider (in Elektromedizin 7/62): Tissue and organ sections with inflammations, necroses, pus formation and abscesses. In such cases, the therapist must choose between the application of cold or heat in accordance with general pathological considerations, depending on the degree of inflammation. Inflammatory conditions that are still in statu nascendi are treated with cold. Inflammatory conditions with necroses and a cavitory tendency are treated with therapeutic means that generate heat and hyperemia. Chronic and unspecific inflammations are treated in the same way (heat and hyperemia), as this supports resorption, reparation and regeneration. Specific chronic inflammations (such as tuberculosis), however, are activated by heat. Accordingly, they represent a contraindication. The same applies in the case of malignant tumorous conditions. Heat application in the case of a tumorous disease can only be regarded as malpractice. Moreover, cardiac congestions must be removed prior to any heat application.
- ²The higher conductivity of metals causes concentration of the field, producing a high temperature in the border area of the tissue. This, in turn, can cause excessive local heat, leading to (irreparable) third-degree burns. Therefore, caution is also necessary in case of long-existing metal inclusions, such as shell fragments.
- ³Further contraindications relating to gynecological disorders include (see Möbius, Gynecological University Clinic, Jena): genital tuberculosis, endometriosis, pyosalpinx or pyoovarium, tubal carcinoma.





Dosage:

- The strength of the electromagnetic field determines the dosage that is applied.
 - Determined by the combination of pulse frequency, pulse width and output power
- Shortwave Diathermy dosimetry is traditionally described as levels I-IV:

Heat Perception	Treatment Dosage			
	I	II	III	IV
None	■			
Low		■		
Medium			■	
Heavy				■



Dosage Levels According to Schliephake

- **Dosage I (Lowest):** No perception of heat (Athermal)
- **Dosage II (Low):** Slight warming (Mild perception of heat)
- **Dosage III (Medium):** Pleasant warming (Comfortable perception of heat)
- **Dosage IV (Heavy):** Strong warming (Strong but tolerable perception of heat)

Always begin the treatment with a low initial dosage.



Dosage Parameters:

Dose	Level	Phase Duration	Frequency	Intensity	Treatment Time
Dose I	Lowest	65 μ sec	100 Hz	Max: 150 W Avg: 0 W	20 Minutes
Dose II	Low	100 μ sec	800 Hz	Max: 150 W Avg: 12 W	20 Minutes
Dose III	Medium	200 μ sec	800 Hz	Max: 150 W Avg: 24 W	20 Minutes
Dose IV	Heavy	400 μ sec	800 Hz	Max: 150 W Avg: 48 W	20 Minutes

Always begin the treatment with a low initial dosage.



Treatment Tips:

- Treatment times depend upon the required depth and area of treatment
 - Shorter times – hands, forearms, ankles, etc.
 - Longer times – thighs, trunk, abdomen, etc.
- Should any discomfort occur, it may be due to excessive output for the condition being treated
 - In such cases, reduce pulse frequency...it is always better to reduce pulse frequency instead of pulse width



Treatment Tips:

- **Electrode Positioning (Inductive)**:**
 - When using the Monode electrode, there should be air space filled with a layer of toweling between the electrode and the skin surface
 - Towel layer (air space between skin and electrode) should be one half inch up to 1.5” of layering with the electrode in contact with the toweling
 - Monode should be placed directly over the area being treated

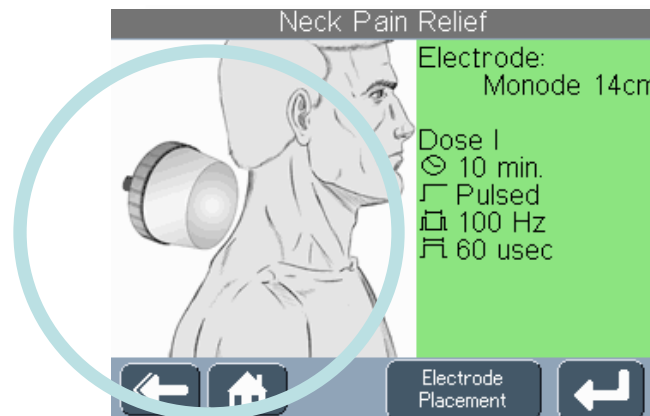

****Evidence-Based Guide to
Therapeutic Physical Agents
Alain-Yvan Belanger**

Treatment Tips:

- **Electrode Positioning (Capacitive):**
 - Position the required electrodes on the part of the body to be treated according to the medical indication
 - Electrode surfaces must be nearly parallel to the area being treated
 - Correct positioning of the electrodes allows for equal distribution and concentrated heating effect

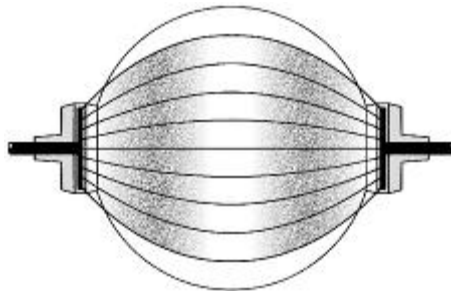

Correct

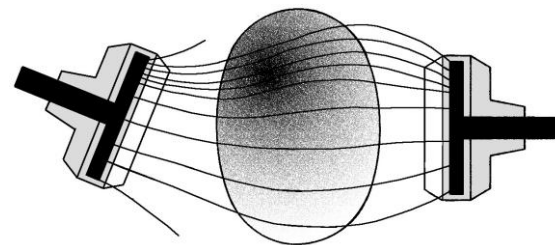

Incorrect

Treatment Tips:

- **Electrode Positioning:**
 - Local overheating can occur due to electrode constrictions
 - This can be prevented by increasing the distance (e.g. with pillow, felt layers, etc.) of the affected body part

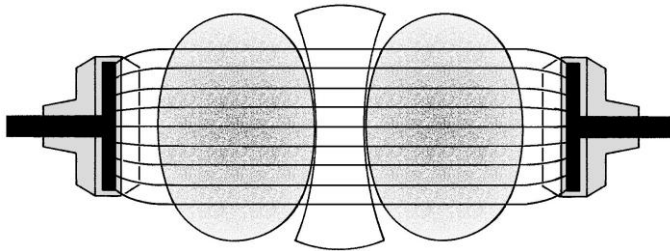

Correct

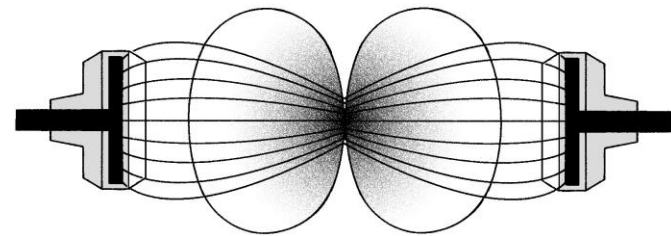

Incorrect

Surface warming can be reduced by increasing the electrode distance



Treatment Tips:

- **Setting Electrode-Skin Distance:**
 - The full power required for successful depth therapy is provided by the unit by using a large Electrode-Skin Distance (ESD)
 - For treatment near the surface, a small ESD is required
 - Adjustment changes are built into the capacitive plates
 - Desired ESD for rubber electrodes can be achieved by varying the number of felt layers underneath
 - Inductive electrodes (monode and diplode) are generally placed in contact with the towel barrier on the body
 - It is recommended that at least a half an inch of towel be used for a barrier

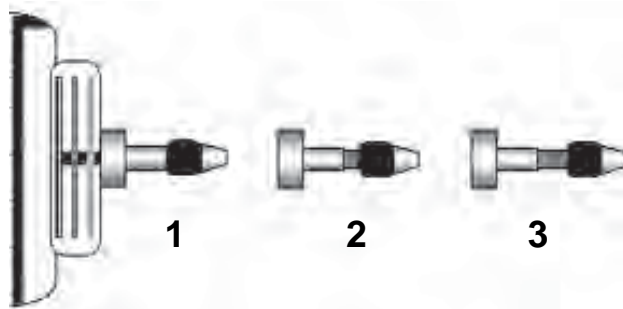

Position	1	2	3
Electrode-Skin Distance	1cm	Approx. 1.75cm	Approx. 2.5cm
Position of the Adjusting Pin	inserted	Half pulled out	Fully pulled out

Capacitive Electrode with Adjusting Pin

[Shortwave
Overview](#)

[Program
Navigation](#)

[Features](#)

Intelect[®]
SHORTWAVE100



Program Navigation:

[Thermal
Dosimetry](#)

[Manual SWD
Settings](#)

[Clinical
Protocols](#)



Program Navigation:

- Treatment can be initiated on the Intelect SWD 100 and the Senior Solutions SWD 100 by 1 of 4 methods:
 - [Manual SWD Settings](#) – set parameters manually on edit screen
 - [Thermal Dosimetry](#) – select dosage level
 - [Clinical Protocols](#) – select from over 90 clinical protocols for 12 body areas
 - User Protocols – select from up to 200 user defined protocols



Thermal Dosimetry:

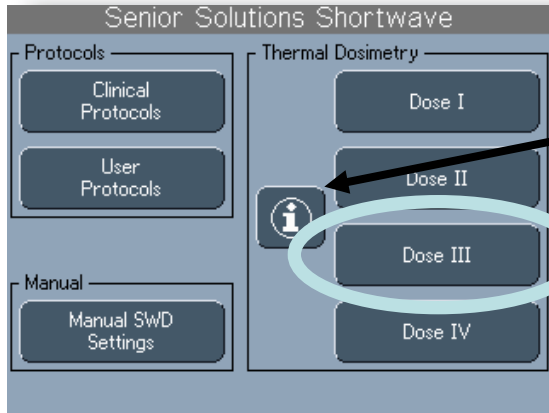

Press the button

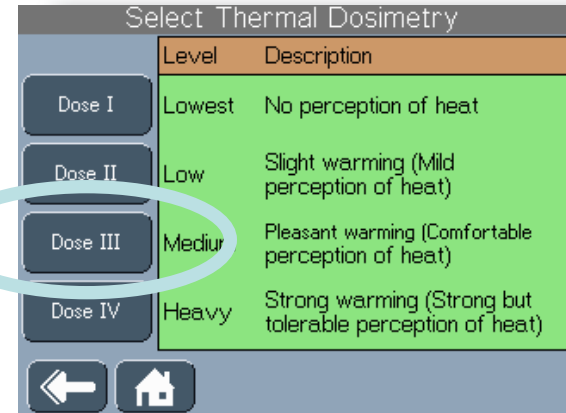

Select Dose Level

Select Dosage

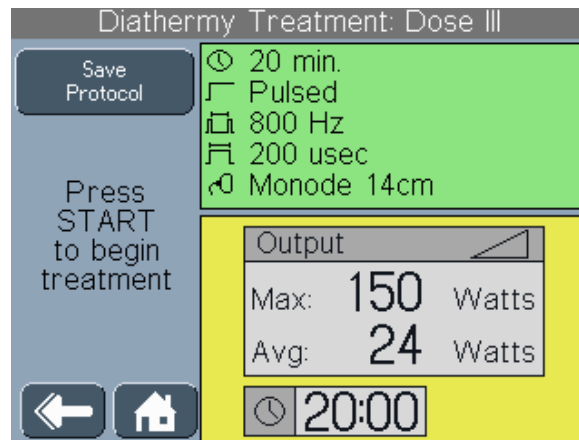
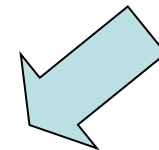
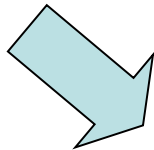

Press start to
begin treatment



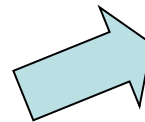
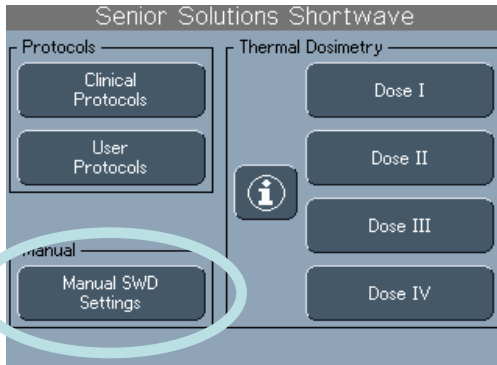

Manual SWD Settings:



Press Edit



Select **Manual SWD Settings**

Adjust each parameter by pressing the  buttons or by pressing and dragging the  button for each parameter

Press **Start** to begin treatment

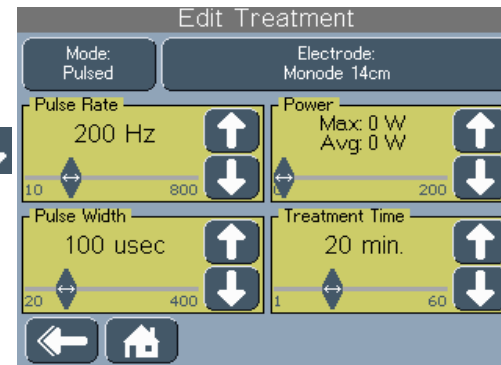
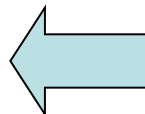

Clinical Protocols:

- Over 90 clinical protocols for multiple body areas provide treatment suggestions

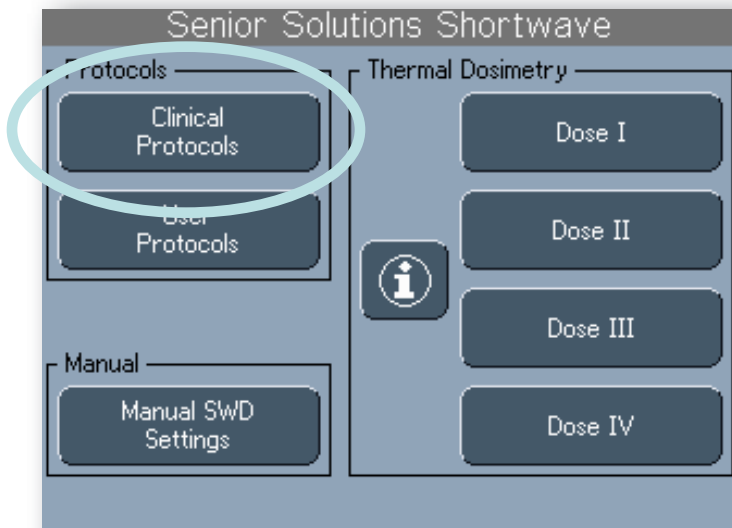

Select **Clinical Protocols**

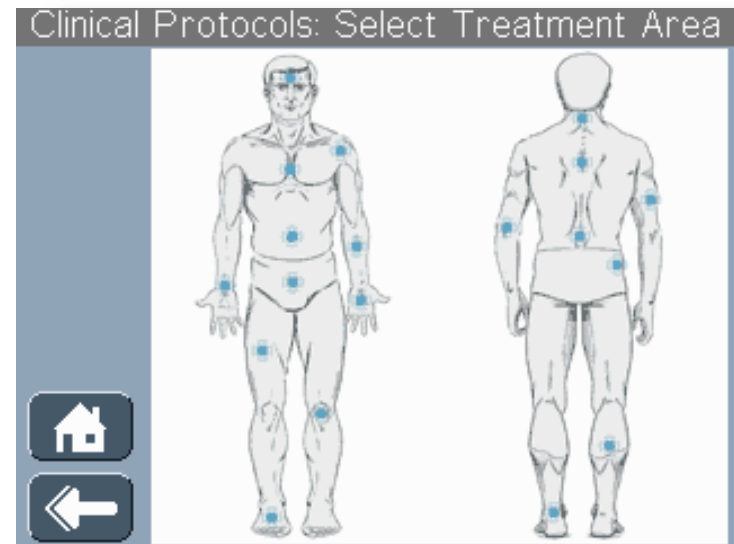
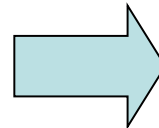

Select one of multiple
body areas



Clinical Protocols:

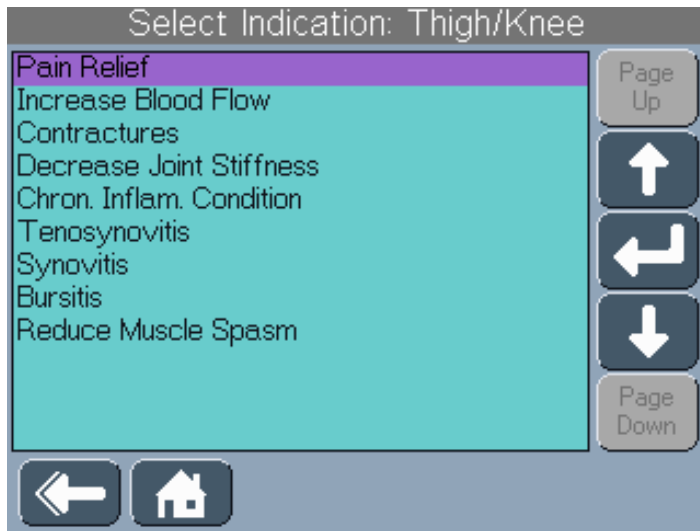

Select indication for the
body area

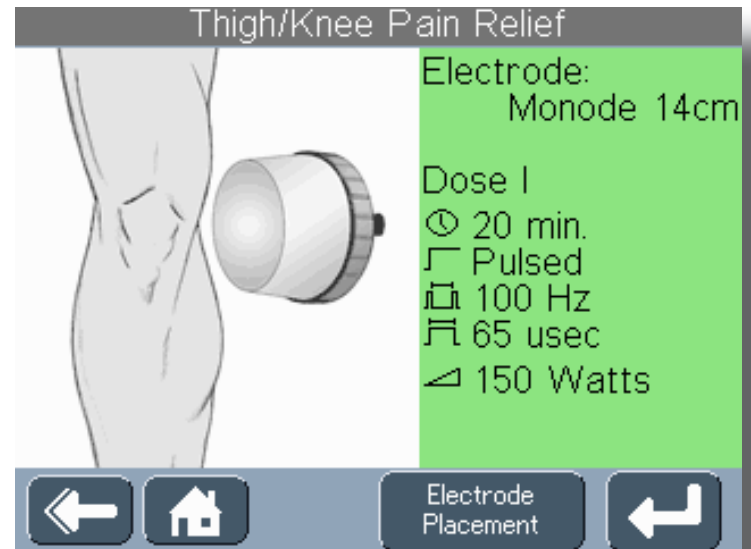
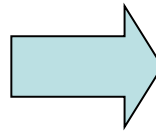

Protocol displays with
default electrode
placement image



Clinical Protocols:

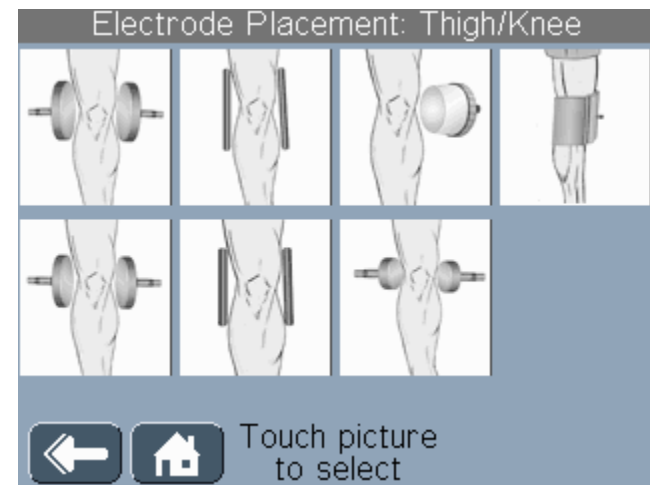
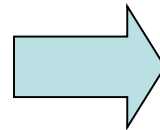
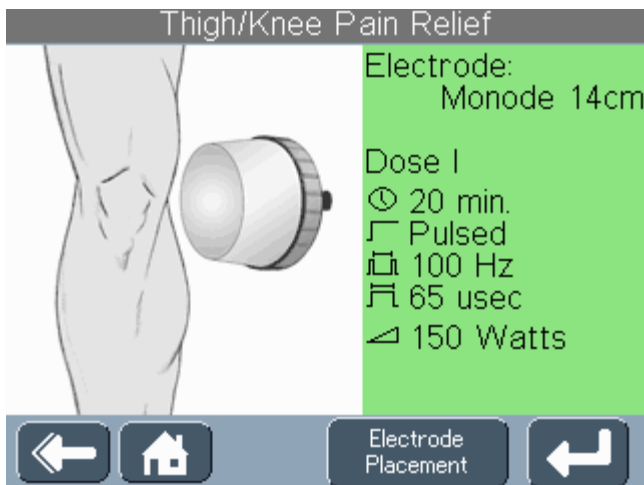

- Press **Start** to begin treatment
- or
- Press **Electrode Placement** to change electrode image

To change electrode, press image desired



Clinical Protocols:

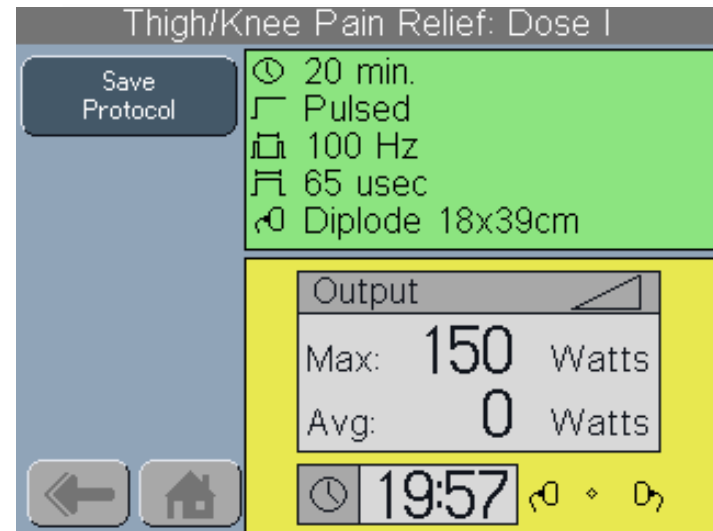
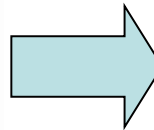
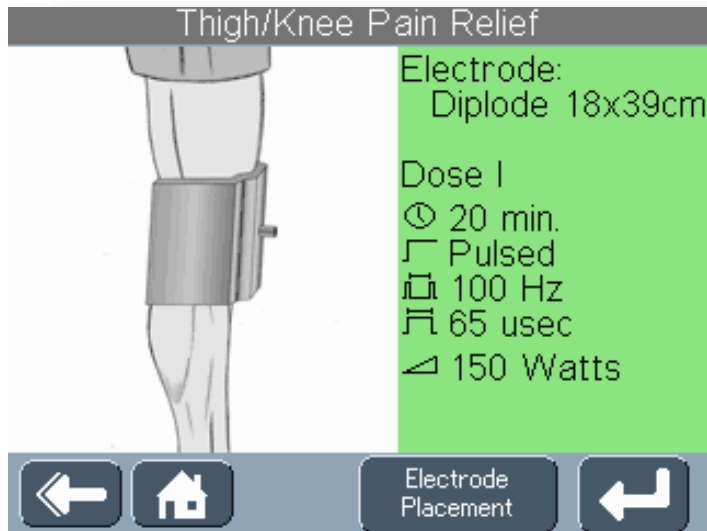

Once new electrode is chosen, press **Start** to begin treatment



Features:

- [Overview](#)
- [Color Touch Screen Interface](#)
- [Electrode Arms/Electrodes](#)
- [Additional Features](#)
- [Standard Package](#)

Overview:

[Fully adjustable
electrode arms](#)

[Color touch screen
interface](#)

360° swivel interface
for convenient
viewing

Grab bar for ease of
movement around
the facility



Pull out storage bin





Color Touch Screen Interface: Full color LCD touch screen interface is intuitive and easy to use

Unique selling feature - Fully adjustable treatment parameters!

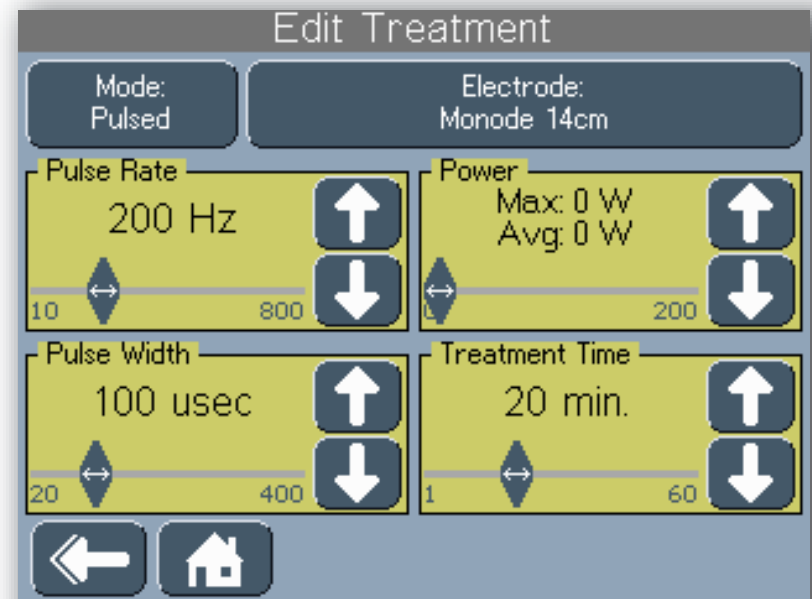



Color Touch Screen Interface

Easy and efficient access to Thermal Dosimetry, Manual SWD Settings and Clinical Protocols

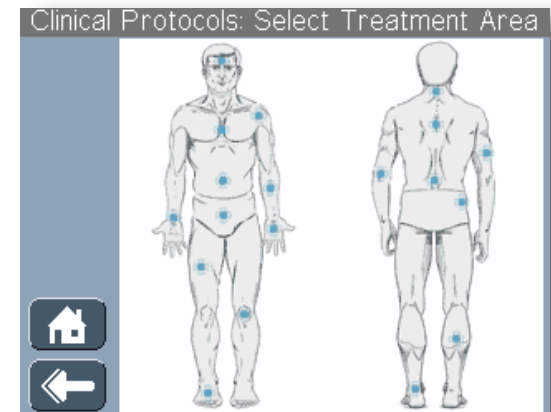
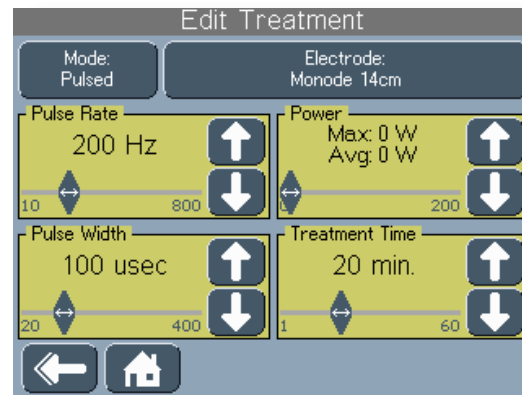
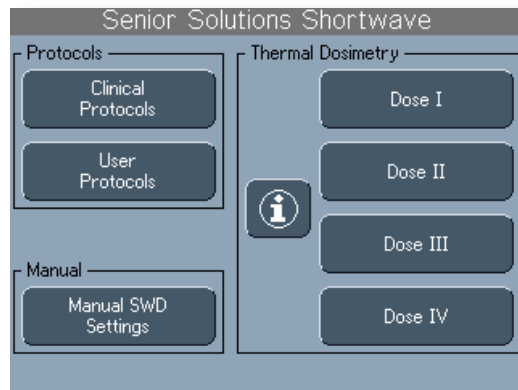



Color Touch Screen Interface

▪ **Clinical Resources**

- Full color graphics library of anatomical images and pathologies
- Electrode placement library
- Shortwave diathermy rationale
- Shortwave diathermy contraindications





Color Touch Screen Interface

- **Clinical Resources**
 - Full color graphics library of anatomical images and pathologies

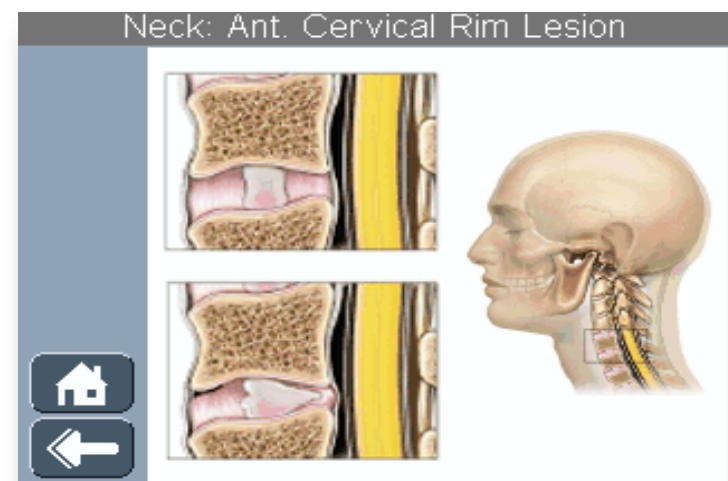
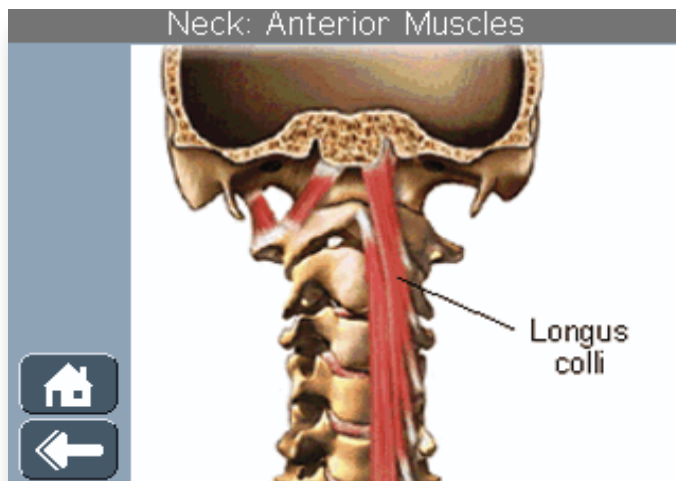



Color Touch Screen Interface

- **Clinical Resources**

- Electrode placement library – over 140 placement images

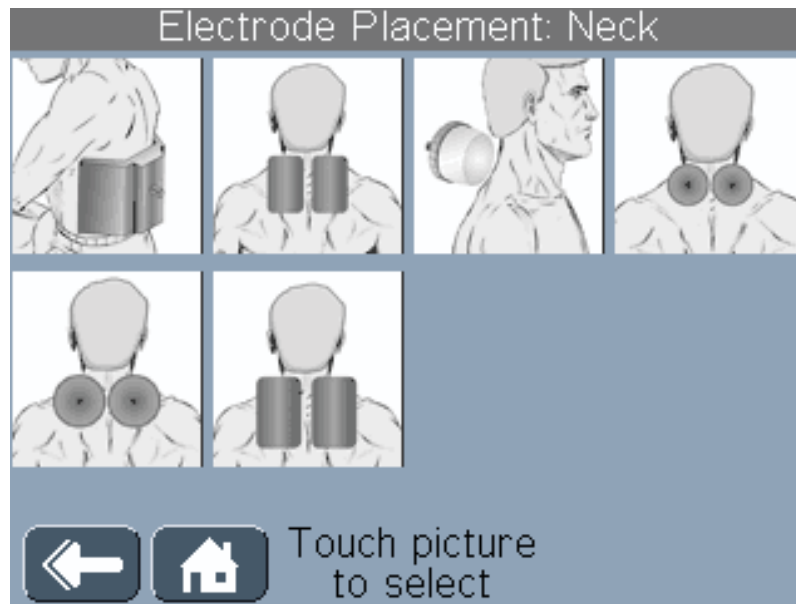



Color Touch Screen Interface

- **Clinical Resources**
 - Shortwave diathermy rationale
 - Shortwave diathermy contraindications

Shortwave Diathermy Rationale

Shortwave Diathermy is the clinical application of electromagnetic energy in the radio frequency of 27.12 megahertz to generate deep heat within body tissues for the treatment of selected medical conditions such as relief of pain, muscle spasms, and joint contractures. The advantage of shortwave diathermy is that it penetrates deeper than other conventional heating techniques such as hot packs, infrared therapy and heating pads. It is also more efficient in the heating of deep muscle tissue than therapeutic ultrasound. Shortwave diathermy can be delivered in either a continuous (CSWD) or pulsed (PSWD) mode. Pulsed mode delivers the energy in pulses or bursts of shortwave energy. In pulsed mode, the average output power of PSWD can be low and still produce effective treatment.

Shortwave diathermy treatments can be applied using either

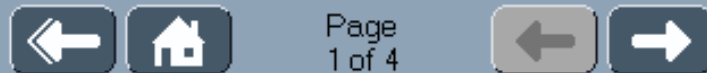

Contraindications

CONTRAINDICATIONS:

- Any patient with an implanted electronic device such as a cardiac pacemaker, bladder stimulator, spinal cord stimulator or electrodes for a myoelectric prosthesis, or implanted metallic leads, must not be treated with shortwave diathermy and should not be subjected to shortwave diathermy. Do not use on patients who have had an implant in the past unless you are absolutely certain that the implant and all leads in their entirety have been removed. Note that leads are often left implanted after the implant is removed. The effects of the applied high frequency on the pacemaker could cause ventricular fibrillation. Any other persons with pacemakers must also remain outside of the treatment area during shortwave diathermy. No one wearing a cardiac pacemaker should be

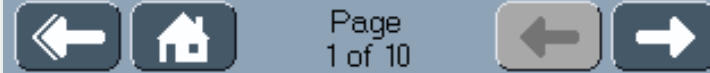



Fully adjustable electrode arms:

- Allow secure and precise electrode positioning for any body area
- Robust, multi-jointed and pivoting

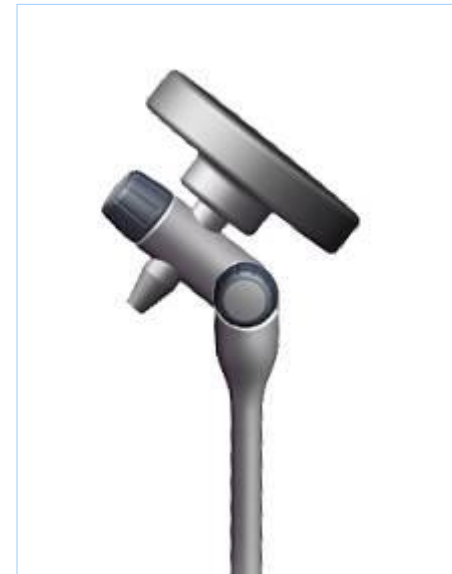
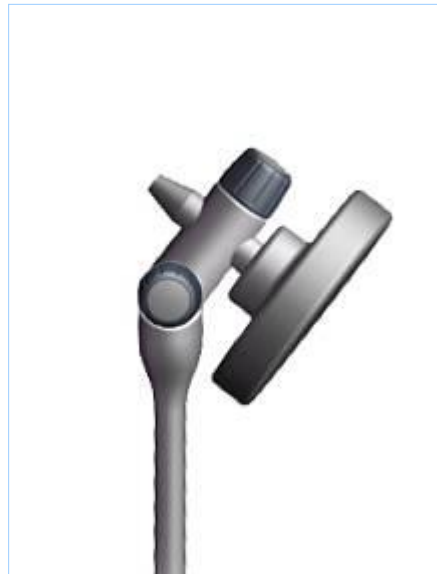

Full range of electrode applicators:

- Monode (standard electrode)
- Diplode
- Capacitive
 - Capacitive Plates: 80mm, 120mm, 165mm
 - Flexible rubber with pad & cover: 180x120mm, 250x145mm





Additional Features:

- Automatic resonance tuning
- Bilingual software
- Continuous (100W) and Pulsed (200W) Modes
- Fully adjustable pulse frequency and pulse width
- Adjustable timer
- Patient safety switch
- Patient documentation of treatment sessions, pre and post treatment patient pain scales, pain mapping and pain types all captured on Patient Data Cards

Standard Package:

- Intelect SWD100
- Inductive Drum (Monode)
- Electrode connection cable
- Electrode arm
- Indicator discharge tube
- User manual on CD
- Quick start guide

